

bench components

components

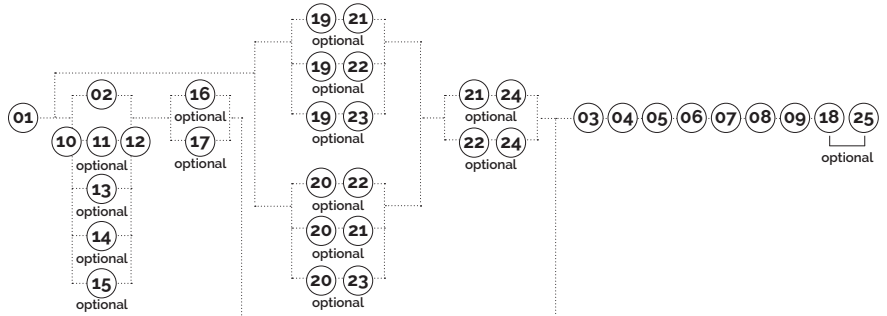

designed by:
ivano dalla val

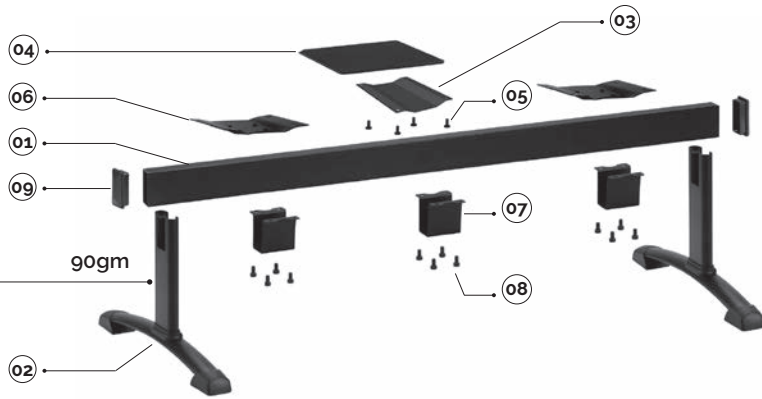

main component sizes

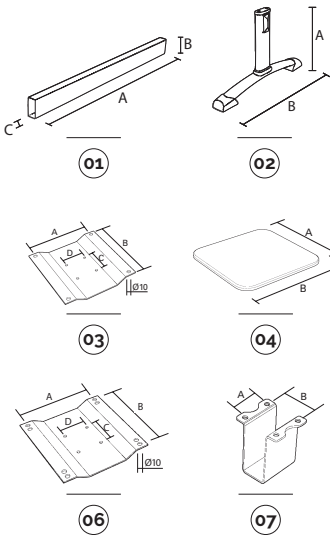

01 90t-poutre pour banquette 90t-viga para bancada

code	finishing		q.kit	q.pack	a	b	c	kg.x1	vol.x1
110703-020	● noir/negro	2 places/2 asientos	x1	1	1000	80	40	2,80	mc. 0,003
110704-043	● gris/gris	2 places/2 asientos	x1	1	1000	80	40	2,80	mc. 0,003
110703-021	● noir/negro	3 places/3 asientos	x1	1	1500	80	40	4,20	mc. 0,0045
110704-044	● gris/gris	3 places/3 asientos	x1	1	1500	80	40	4,20	mc. 0,0045
110703-022	● noir/negro	4 places/4 asientos	x1	1	2000	80	40	5,60	mc. 0,006
110704-045	● gris/gris	4 places/4 asientos	x1	1	2000	80	40	5,60	mc. 0,006
110703-023	● noir/negro	5 places/5 asientos	x1	1	2500	80	40	7,00	mc. 0,0085
110704-046	● gris/gris	5 places/5 asientos	x1	1	2500	80	40	7,00	mc. 0,0085

02 90ap-pied mobile pour banquette avec accessoires 90ap-pata móvil para bancada con accesorios

code	finishing		q.kit	q.pack	a	b	kg.x1	vol.x1
110703-005	● noir/negro		x2	2	380	600	2,70	mc. 0,012
110704-001	● gris/gris		x2	2	380	600	2,70	mc. 0,012
110710-001	● chromé/cromado		x2	2	380	600	2,70	mc. 0,012

03 90ap-raccordement porte plateau 90ap-enganche soporte mesa

code	finishing		q.kit	q.pack	a	b	c	d	kg.x1	vol.x1
110703-014	● noir/negro		x1	25	170	200	65	55	1,00	mc. 0,0002
110704-019	● gris/gris		x1	25	170	200	65	55	1,00	mc. 0,0002

04 90tn-plateau de table pour banquette 90tn-mesa para bancada

code	finishing		q.kit	q.pack	a	b	kg.x1	vol.x1
120303-001	● noir/negro		x1	10	400	400	2,20	mc. 0,002

05 vis tc + m6x12 brunie noire tornillo tc + m6x12 bruñido negro

code	finishing		q.kit
117703-177	● noir/negro		x4

06 92p-plaquette pour banquette vernie 92p-placa para bancada pintada

code	finishing		q.kit	q.pack	a	b	c	d	kg.x1	vol.x1
110703-013	● noir/negro		x1	25	153	200	65	55	0,85	mc. 0,0008

07 90cv-cavalier pour dessous poutre 90cv-caballete bajo viga

code	finishing		q.kit	q.pack	a	b	kg.x1	vol.x1
110703-007	● noir/negro		x1	50	55	65	0,60	mc. 0,0005
110704-015	● gris/gris		x1	50	55	65	0,60	mc. 0,0005

08 pack vis m8x12 tête cylindrique hexagonale encaissée brunie noire paquete de tornillos m8x12 cabeza cilíndrica hexagonal embutida bruñido negro

code	finishing		q.kit	q.pack
117003-070	● noir/negro		x4	200

09 embout couvre-tête rectangulaire 80x40 noir tapón embellecedor rectangular 80 x 40 negro

code	finishing		q.kit
134103-001	● noir/negro		x2

bench leg & arm options

components

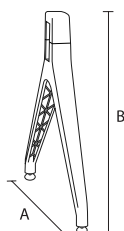

- 10 jim-pied en plastique noir
jim-pata de plástico negra



certification / Jim



EN16139

code	finishing	q.kit	q.pack	a	b	kg.x1	vol.x1
130703-004	● noir/negro	x2	10	630	425	0,95	mc. 0,0102

- 11 jim-cavalier d'assemblage pour pied noir en plastique
jim-caballette para fijación pata en plástico negro

code	finishing	q.kit	q.pack	kg.x1	vol.x1
130703-005	● noir/negro	x2	10	0,16	mc. 0,0005

- 12 jim-kit accessoires pour 10 pieds
jim-kit de accesorios para 10 patas

code	finishing	q.kit	q.pack	kg.x1	vol.x1
130703-007	● noir/negro	x0,2	1	0,15	mc. 0,0004

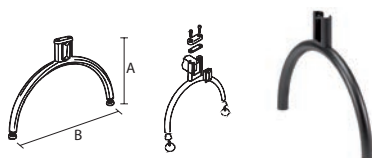

- 13 100gm-pied mobile pour banquette avec accessoires
100gm-pata móvil para bancada con accesorios

code	finishing	q.kit	q.pack	a	b	kg.x1	vol.x1
110703-008	● noir/negro	x2	2	380	600	2,10	mc. 0,012
110704-006	● gris/gris	x2	2	380	600	2,10	mc. 0,012
110710-005	● chromé/cromado	x2	2	380	600	2,10	mc. 0,012

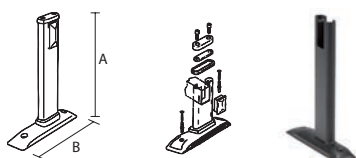

- 14 90gf-pied fixe pour banquette avec accessoires
90gf-pata fija para bancada con accesorios

code	finishing	q.kit	q.pack	a	b	kg.x1	vol.x1
110703-030	● noir/negro	x2	2	380	310	1,90	mc. 0,012
110704-012	● gris/gris	x2	2	380	310	1,90	mc. 0,012

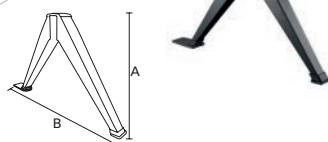

- 15 200gm-pied mobile pour banquette avec accessoires
200gm-pata móvil para bancada con accesorios

code	finishing	q.kit	q.pack	a	b	kg.x1	vol.x1
110703-110	● noir/negro	x2	4	380	600	2,60	mc. 0,005
110704-110	● gris/gris	x2	4	380	600	2,60	mc. 0,005
110710-110	● chromé/cromado	x2	4	380	600	2,60	mc. 0,005

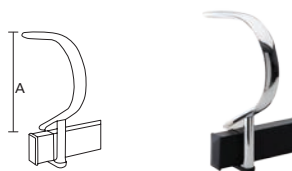

- 16 pioneer-accoudoir elliptique 40x20 pour banquette avec accessoires
pioneer-brazo elíptico 40x20 para bancada con accesorios

code	finishing	q.kit	q.pack	a	kg.x1	vol.x1
111703-015	● noir/negro	x1	5	260	1,10	mc. 0,005
111704-015	● gris/gris	x1	5	260	1,10	mc. 0,005
111710-015	● chromé/cromado	x1	5	260	1,10	mc. 0,005

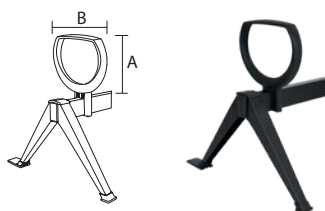

- 17 apoll-accoudoir en plastique + cavalier pour banquette
apoll-brazo de plástico + caballette para bancada

code	finishing	q.kit	q.pack	a	b	kg.x1	vol.x1
131703-065	● noir/negro	x1	10	275	300	0,90	mc. 0,008

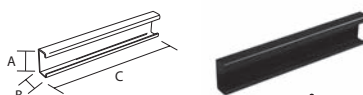

- 18 liaison poutre banquette empalme viga bancada

code	finishing	q.kit	q.pack	a	b	b	kg.x1
110703-025	● noir/negro	x1	10	75	36	400	1,42

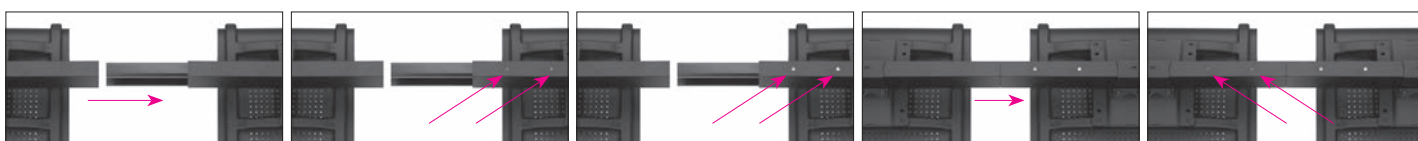

01

02

03

04

05

bench leg & arm options

components / cut & slim options



designed by:
alessandro crosera

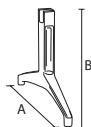

19 cut-pied en aluminium pour banquette + 2 pieds
cut-pata de aluminio para bancada + n. 2 pies

code	finishing	q.kit	q.pack	a	b	kg.x1	vol.x1
111704-224	⊖ aluminium/aluminio	x2	5	610	350	2,75	mc. 0,0132

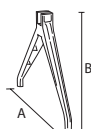

20 slim-pied en aluminium pour banquette + 2 pieds
slim-pata de aluminio para bancada + n. 2 pies

code	finishing	q.kit	q.pack	a	b	kg.x1	vol.x1
111704-226	⊖ aluminium/aluminio	x2	5	610	350	1,3125	mc. 0,0102



21 cut-accoudoir en aluminium pour banquette + 2 vis
cut-brazo de aluminio para bancada + n. 2 tornillos

code	finishing	q.kit	q.pack	a	b	kg.x1	vol.x1
111704-223	⊖ aluminium/aluminio	x1	10	300	305	1,6065	mc. 0,0028



22 slim-accoudoir en aluminium pour banquette + 2 vis
slim-brazo de aluminio para bancada + n. 2 tornillos

code	finishing	q.kit	q.pack	a	b	kg.x1	vol.x1
111704-225	⊖ aluminium/aluminio	x1	10	325	305	1,464	mc. 0,0049



23 cut/slim-cavalier en aluminium pour pied banquette + 2 vis
cut/slim caballete de aluminio para pata bancada + n. 2 tornillos

code	finishing	q.kit	q.pack	a	b	kg.x1	vol.x1
111704-222	⊖ aluminium/aluminio	x2	10	60	95	0,30	mc. 0,0005

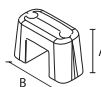

24 cut/slim-cavalier en aluminium pour accoudoir banquette
cut/slim caballete de aluminio para brazo bancada

code	finishing	q.kit	q.pack	a	b	kg.x1	vol.x1
111704-221	⊖ aluminium/aluminio	x1	10	58	95	0,38	mc. 0,0005

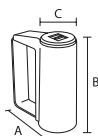

25 e:usb-charger pour banquette
e:usb-cargador para bancada

code	finishing	q.kit	q.pack	a	b	c	kg.x1	vol.x1
130703-002	● noir/negro	x1	5	85	100	38	0,28	mc. 0,0009

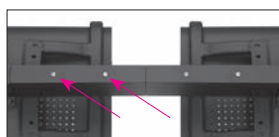

06



07

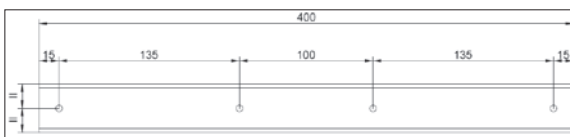

→ trame de perçage conseillée, côté bas poutre
perforación aconsejada, lado inferior viga